

SCHEDULE 40 AND SCHEDULE 80 ETL LISTED PVC RIGID NONMETALLIC CONDUIT AND ELBOWS



Schedule 40 Standard Radius

Schedule 40 Special Radius

Schedule 80 Standard Radius

Schedule 80 Special Radius

Schedule 40 Conduit

Schedule 80 Conduit





Schedule 40 and Schedule 80 PVC Rigid Nonmetallic (RNC) Conduit

Prime Conduit® manufactures the most complete line of nonmetallic conduits in the electrical industry. Prime Conduit Schedule 40 and Schedule 80 conduits are designed for use aboveground and underground as described in the National Electrical Code. Specify only Prime Conduit conduits to insure raceway system quality.

Features

- **Ease of Installation** Nonmetallic conduits are $\frac{1}{4}$ to $\frac{1}{5}$ the weight of metallic systems, can be installed in less than half the time, and are easily fabricated on the job.
- **Safety** Nonmetallic conduits are nonconductive, assuring a safe system.
- **Impact Resistant** Prime Conduit Schedule 40 and Schedule 80 nonmetallic conduits are resistant to sunlight and are listed for exposed or outdoor usage.
- **Corrosion Resistant** Prime Conduit conduits are nonmetallic and will not rust or corrode.
- **Standards** Prime Conduit nonmetallic Schedule 40 and Schedule 80 conduit is manufactured to NEMA TC-2, Federal specification W-C-1094A and UL 651 specifications. The conduit carries respective ETL Listings and ETL labels.

Support of Prime Conduit Rigid Nonmetallic Conduit in Aboveground Installations

Table 352.30(B) NEC shows the support requirements for Schedule 40 and Schedule 80 rigid PVC nonmetallic conduit.

Plastic conduit should always be installed away from steam lines, etc. Support straps should allow for lineal movement caused by expansion and contraction.

Maximum ambient temperature is 122°F (50°C).

Table 352.30(B)

| Conduit Trade Size | Maximum Spacing Between Supports (feet) |
|-----------------------|---|
| $\frac{1}{2}$ " - 1" | 3 |
| $1\frac{1}{4}$ " - 2" | 5 |
| $2\frac{1}{2}$ " - 3" | 6 |
| $3\frac{1}{2}$ " - 5" | 7 |
| 6" | 8 |



Schedule 40 PVC Rigid Nonmetallic Conduit

- ETL Listed to UL651 in compliance with the NEC
- Heavy Wall EPC
- Listed for underground applications encased in concrete or direct burial.
- Also for use in exposed or concealed applications aboveground.
- Sunlight resistant
- Rated for use with 90°C conductors
- Superior weathering characteristics
- Made in USA
- Integral Bell Dimensions meet the requirements of UL651



*With Integral Bell

| Part Number | | Trade Size | Std. Crate Qty. | | Wt. Per 100' | O.D. (Avg.) | Wall (Min.) |
|-------------|-----------|------------|-----------------|-------|--------------|-------------|-------------|
| 10' | 20' | | 10' | 20' | | | |
| 49005-010 | - | 1/2" | 6000' | - | 17 | 0.840 | 0.109 |
| 49007-010 | 49007-020 | 3/4" | 4400' | 8800' | 23 | 1.050 | 0.113 |
| 49008-010 | 49008-020 | 1" | 3600' | 7200' | 34 | 1.315 | 0.133 |
| 49009-010 | 49009-020 | 1 1/4" | 3300' | 6600' | 46 | 1.660 | 0.140 |
| 49010-010 | 49010-020 | 1 1/2" | 2250' | 4500' | 55 | 1.900 | 0.145 |
| 49011-010 | 49011-020 | 2" | 1400' | 2800' | 73 | 2.375 | 0.154 |
| 49012-010 | 49012-020 | 2 1/2" | 930' | 1860' | 124 | 2.875 | 0.203 |
| 49013-010 | 49013-020 | 3" | 880' | 1760' | 163 | 3.500 | 0.216 |
| 49014-010 | 49014-020 | 3 1/2" | 630' | 1260' | 196 | 4.000 | 0.226 |
| 49015-010 | 49015-020 | 4" | 570' | 1140' | 232 | 4.500 | 0.237 |
| 49016-010 | 49016-020 | 5" | 380' | 760' | 315 | 5.563 | 0.258 |
| 49017-010 | 49017-020 | 6" | 260' | 520' | 409 | 6.625 | 0.280 |



Notes:

1. Rigid nonmetallic conduit is normally supplied in standard 10' lengths, with one belled end per length. For specific requirements, it may be produced in lengths shorter or longer than 10', with or without belled ends
2. Special conduit sizes will be quoted on request.
3. DON'T FORGET TO ORDER CEMENT.
4. Use RNC Fittings with Schedule 40 and Schedule 80 Conduit
5. Prime Conduit reserves the right to ship to the nearest unitized quantity.



- ETL Listed to UL651 in compliance to the NEC
- Extra Heavy Wall EPC-80
- Listed for use in aboveground and belowground applications including areas subject to physical damage.
- Sunlight resistant
- Rated for use with 90°C conductors
- Superior weathering characteristics
- Identified for use in areas subject to physical damage in accordance to 352.12(C)
- Made in the USA
- Integral Bell Dimensions meet the requirements of UL651



| Part Number | | Trade | Std. Crate Qty. | | Wt. Per | O.D. | Wall |
|-------------|-----------|--------|-----------------|--------|---------|--------|--------|
| 10' | 20' | Size | 10' | 20' | 100' | (Avg.) | (Min.) |
| 49405-010 | 49405-020 | 1/2" | 6000' | 12000' | 21 | 0.840 | 0.147 |
| 49407-010 | 49407-020 | 3/4" | 4400' | 8000' | 30 | 1.050 | 0.154 |
| 49408-010 | 49408-020 | 1" | 3600' | 7200' | 44 | 1.315 | 0.179 |
| 49409-010 | 49409-020 | 1 1/4" | 3300' | 6600' | 60 | 1.660 | 0.191 |
| 49410-010 | 49410-020 | 1 1/2" | 2250' | 3600' | 72 | 1.900 | 0.200 |
| 49411-010 | 49411-020 | 2" | 1400' | 2800' | 101 | 2.375 | 0.218 |
| 49412-010 | 49412-020 | 2 1/2" | 930' | 1880' | 154 | 2.875 | 0.276 |
| 49413-010 | 49413-020 | 3" | 880' | 1760' | 210 | 3.500 | 0.300 |
| 49415-010 | 49415-020 | 4" | 570' | 1140' | 308 | 4.500 | 0.337 |
| 49416-010 | — | 5" | 380' | — | 428 | 5.563 | 0.375 |
| 49417-010 | 49417-020 | 6" | 260' | 520' | 588 | 6.625 | 0.432 |

*With Integral Bell



Notes:

1. Rigid nonmetallic conduit is normally supplied in standard 10' lengths, with one belled end per length. For specific requirements, it may be produced in lengths shorter or longer than 10', with or without belled ends
2. Special conduit sizes will be quoted on request.
3. DON'T FORGET TO ORDER CEMENT.
4. Use RNC Fittings with Schedule 40 and 80 Conduit
5. Prime Conduit reserves the right to ship to the nearest unitized quantity.

Prime Conduit PVC Elbows and Sweeps Part Numbering System

| Prime Conduit Elbows and Sweeps Part Numbering System | | | | | |
|---|---------|-----|-------------|--------|------------|
| Position: | 1 | 2 | 3 | 4 | 5 |
| Letter/Number: | UA | 7 | A | K | |
| Description: | Sch. 40 | 45° | Std. Radius | 2 1/2" | Non-Belled |

1: Product Line

- UA = Schedule 40 Heavy Wall EPC
- UB = Schedule 80 Extra Heavy Wall EPC
- UC = Schedule 40 Heavy Wall Utility Conduit*
- PE = DB-100 Sweeps*
- PF = DB-60 Sweeps*
- PH = DB-120 Sweeps*
- TP = Telephone Duct "C" Sweeps*
- TW = White Telephone Duct "C" Sweeps*



* Non-ETL Listed

2: Angle

- 9 = 90° Elbow
- 7 = 45° Elbow
- 6 = 30° Elbow
- 5 = 22 1/2° Elbow
- 3 = 11 1/4° Elbow

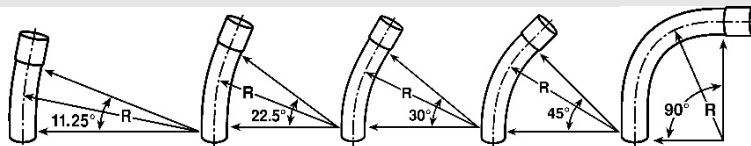

3: Radius

- A = Standard Radius
- B = 12"
- C = 18"
- D = 24"
- E = 30"
- F = 36"
- H = 48"
- I = 60"
- J = 72"
- N = 120"
- R = 144"
- S = 150"
- T = 180"
- U = 240"
- V = 300"

4: Diameter

- | | |
|------------|------------|
| D = 1/2" | L = 3" |
| E = 3/4" | M = 3 1/2" |
| F = 1" | N = 4" |
| G = 1 1/4" | P = 5" |
| H = 1 1/2" | R = 6" |
| J = 2" | T = 8" |
| K = 2 1/2" | |



5: Belled Elbow

- B = Belled; All DB-100, DB-60, DB-120, and Telephone Duct sweeps are belled and do not have the "B" in position 5.
- S = Segmented



Schedule 40 and 80 PVC Rigid Nonmetallic Elbows

Sales Information:

- ETL Listed to UL 651 in compliance with the NEC.
- Meets NEMA TC3 - *Polyvinyl Chloride (PVC) Fittings for Use with Rigid PVC Conduit and Tubing.*
- Not all configurations are stocked.
- Elbows 72" and larger may be shipped in segments.
- Contact your local Rep for more information.
- Consult factory for additional sizes/configurations.

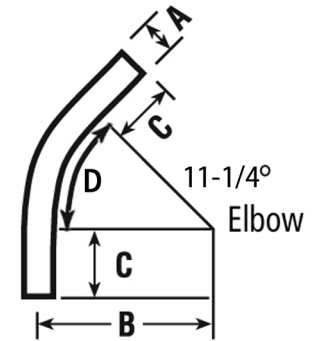

Dimensional Information:

- Dimensions are nominal.
- Average outer diameter per UL651, Table 4.1
- Minimum standard radius per UL 651, Table 4.10
- Minimum tangent length per UL651, Table 4.10
- Integral belled end dimensions per U651, Table 4.4

| Trade Size | Average OD "A" | Min. Standard Radius "B" | Special Radius "B" | Min. Tangent Length "C" | Arc Length "D" |
|------------|----------------|--------------------------|---|-------------------------|-------------------------|
| 1/2" | 0.840" | 4" | See part number list on the special radius elbow pages. | 1 1/2" | *See calculation below. |
| 3/4" | 1.050" | 4 1/2" | | 1 1/2" | |
| 1" | 1.315" | 5 3/4" | | 1 7/8" | |
| 1 1/4" | 1.660" | 7 1/4" | | 2" | |
| 1 1/2" | 1.900" | 8 1/4" | | 2" | |
| 2" | 2.375" | 9 1/2" | | 2" | |
| 2 1/2" | 2.875" | 10 1/2" | | 3" | |
| 3" | 3.500" | 13" | | 3 1/8" | |
| 3 1/2" | 4.000" | 15" | | 3 1/4" | |
| 4" | 4.500" | 16" | | 3 3/8" | |
| 5" | 5.563" | 24" | | 3 5/8" | |
| 6" | 6.625" | 30" | | 3 3/4" | |

*Arc Length "D" = $[2 * \text{Radius}] * \pi * [\text{Angle}/360]$

Example: Arc Length_{UA3AD} = $[2*4] * 3.14 * [11.25/360] = 0.79"$

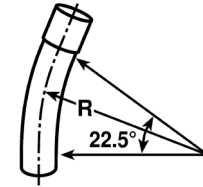
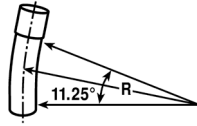

| Part Number | Trade Size | Type | Package Quantity | EACH UPC |
|-------------|------------|-----------|------------------|--------------|
| UA3AD | 1/2" | PLAIN END | 50 | 670648079838 |
| UA3AE | 3/4" | PLAIN END | 25 | 670648079845 |
| UA3AF | 1" | PLAIN END | 25 | 670648079920 |
| UA3AG | 1-1/4" | PLAIN END | 20 | 670648079937 |
| UA3AH | 1-1/2" | PLAIN END | 25 | 670648337716 |
| UA3AJ | 2" | PLAIN END | 20 | 670648337730 |
| UA3AK | 2-1/2" | PLAIN END | 10 | 670648337754 |
| UA3AL | 3" | PLAIN END | 25 | 670648337761 |
| UA3AM | 3-1/2" | PLAIN END | 16 | 670648079944 |
| UA3AN | 4" | PLAIN END | 16 | 670648224481 |
| UA3ANB | 4" | BELL END | 16 | 670648224498 |
| UA3AP | 5" | PLAIN END | 50 | 670648337778 |
| UA3AR | 6" | PLAIN END | 12 | 670648224511 |

| Part Number | Trade Size | Type | Package Quantity | EACH UPC |
|-------------|------------|-----------|------------------|--------------|
| UA5AD | 1/2" | PLAIN END | 50 | 670648079913 |
| UA5AE | 3/4" | PLAIN END | 25 | 670648225204 |
| UA5AF | 1" | PLAIN END | 20 | 670648225211 |
| UA5AG | 1-1/4" | PLAIN END | 25 | 670648338331 |
| UA5AH | 1-1/2" | PLAIN END | 20 | 670648225242 |
| UA5AJ | 2" | PLAIN END | 25 | 670648225266 |
| UA5AJB | 2" | BELL END | 25 | 670648225273 |
| UA5AK | 2-1/2" | PLAIN END | 20 | 670648225280 |
| UA5AL | 3" | PLAIN END | 20 | 670648225303 |
| UA5ALB | 3" | BELL END | 12 | 670648225310 |
| UA5AM | 3-1/2" | PLAIN END | 8 | 670648338355 |
| UA5AN | 4" | PLAIN END | 12 | 670648225334 |
| UA5ANB | 4" | BELL END | 12 | 670648225341 |
| UA5AP | 5" | PLAIN END | 5 | 670648225358 |
| UA5APB | 5" | BELL END | 3 | 670648079616 |
| UA5AR | 6" | PLAIN END | 16 | 670648225372 |
| UA5ARB | 6" | BELL END | 16 | 670648225389 |

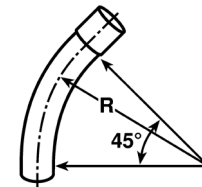
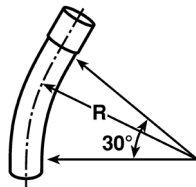

| Part Number | Trade Size | Type | Package Quantity | EACH UPC |
|-------------|------------|-----------|------------------|--------------|
| UA6AD | 1/2" | PLAIN END | 50 | 670648060812 |
| UA6ADB | 1/2" | BELL END | 50 | 670648054538 |
| UA6AE | 3/4" | PLAIN END | 25 | 670648060829 |
| UA6AEB | 3/4" | BELL END | 25 | 670648054545 |
| UA6AF | 1" | PLAIN END | 20 | 670648060836 |
| UA6AFB | 1" | BELL END | 20 | 670648054569 |
| UA6AG | 1-1/4" | PLAIN END | 25 | 670648060843 |
| UA6AGB | 1-1/4" | BELL END | 20 | 670648196382 |
| UA6AH | 1-1/2" | PLAIN END | 50 | 670648060850 |
| UA6AHB | 1-1/2" | BELL END | 25 | 670648196399 |
| UA6AJ | 2" | PLAIN END | 20 | 670648060867 |
| UA6AJB | 2" | BELL END | 20 | 670648196405 |
| UA6AK | 2-1/2" | PLAIN END | 20 | 670648060874 |
| UA6AKB | 2-1/2" | BELL END | 20 | 670648196412 |
| UA6AL | 3" | PLAIN END | 18 | 670648060881 |
| UA6ALB | 3" | BELL END | 18 | 670648196429 |
| UA6AM | 3-1/2" | PLAIN END | 12 | 670648060898 |
| UA6AMB | 3-1/2" | BELL END | 10 | 670648196436 |
| UA6AN | 4" | PLAIN END | 10 | 670648060904 |
| UA6ANB | 4" | BELL END | 10 | 670648196443 |
| UA6AP | 5" | PLAIN END | 5 | 670648060928 |
| UA6APB | 5" | BELL END | 5 | 670648196450 |
| UA6AR | 6" | PLAIN END | 12 | 670648060942 |
| UA6ARB | 6" | BELL END | 16 | 670648196467 |

| Part Number | Trade Size | Type | Package Quantity | EACH UPC |
|-------------|------------|-----------|------------------|--------------|
| UA7AD | 1/2" | PLAIN END | 50 | 670648060614 |
| UA7ADB | 1/2" | BELL END | 50 | 670648039009 |
| UA7AE | 3/4" | PLAIN END | 25 | 670648060621 |
| UA7AEB | 3/4" | BELL END | 25 | 670648039016 |
| UA7AF | 1" | PLAIN END | 20 | 670648060638 |
| UA7AFB | 1" | BELL END | 20 | 670648039023 |
| UA7AG | 1-1/4" | PLAIN END | 25 | 670648060645 |
| UA7AGB | 1-1/4" | BELL END | 25 | 670648196290 |
| UA7AH | 1-1/2" | PLAIN END | 20 | 670648060652 |
| UA7AHB | 1-1/2" | BELL END | 30 | 670648196306 |
| UA7AJ | 2" | PLAIN END | 20 | 670648060669 |
| UA7AJB | 2" | BELL END | 20 | 670648196320 |
| UA7AK | 2-1/2" | PLAIN END | 20 | 670648226102 |
| UA7AKB | 2-1/2" | BELL END | 20 | 670648226119 |
| UA7AL | 3" | PLAIN END | 10 | 670648060683 |
| UA7ALB | 3" | BELL END | 12 | 670648196337 |
| UA7AM | 3-1/2" | PLAIN END | 5 | 670648060690 |
| UA7AMB | 3-1/2" | BELL END | 40 | 670648196344 |
| UA7AN | 4" | PLAIN END | 80 | 670648060607 |
| UA7ANB | 4" | BELL END | 5 | 670648196351 |
| UA7AP | 5" | PLAIN END | 8 | 670648060720 |
| UA7APB | 5" | BELL END | 8 | 670648196368 |
| UA7AR | 6" | PLAIN END | 12 | 670648060744 |
| UA7ARB | 6" | BELL END | 8 | 670648196375 |

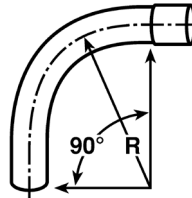

| Part Number | Trade Size | Type | Package Quantity | EACH UPC |
|-------------|------------|-----------|------------------|--------------|
| UA9AD | 1/2" | PLAIN END | 50 | 670648060416 |
| UA9ADB | 1/2" | BELL END | 50 | 670648226980 |
| UA9AE | 3/4" | PLAIN END | 35 | 670648060423 |
| UA9AEB | 3/4" | BELL END | 35 | 670648227017 |
| UA9AF | 1" | PLAIN END | 20 | 670648060430 |
| UA9AFB | 1" | BELL END | 20 | 670648227048 |
| UA9AG | 1-1/4" | PLAIN END | 30 | 670648060447 |
| UA9AGB | 1-1/4" | BELL END | 30 | 670648196207 |
| UA9AH | 1-1/2" | PLAIN END | 30 | 670648060454 |
| UA9AHB | 1-1/2" | BELL END | 30 | 670648196214 |
| UA9AJ | 2" | PLAIN END | 20 | 670648060461 |
| UA9AJB | 2" | BELL END | 20 | 670648196221 |
| UA9AK | 2-1/2" | PLAIN END | 10 | 670648060478 |
| UA9AKB | 2-1/2" | BELL END | 10 | 670648196238 |
| UA9AL | 3" | PLAIN END | 128 | 670648060485 |
| UA9ALB | 3" | BELL END | 128 | 670648196245 |
| UA9AM | 3-1/2" | PLAIN END | 80 | 670648060492 |
| UA9AMB | 3-1/2" | BELL END | 40 | 670648196252 |
| UA9AN | 4" | PLAIN END | 42 | 670648060508 |
| UA9ANB | 4" | BELL END | 42 | 670648196269 |
| UA9AP | 5" | PLAIN END | 8 | 670648060522 |
| UA9APB | 5" | BELL END | 8 | 670648196276 |
| UA9AR | 6" | PLAIN END | 8 | 670648060546 |
| UA9ARB | 6" | BELL END | 8 | 670648196283 |

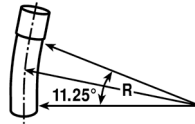

| Part Number | Trade Size | Type | Radius "B" | EACH UPC | Package Quantity |
|-------------|------------|-----------|------------|--------------|------------------|
| UA3DJ | 2" | PLAIN END | 24" | 670648224535 | 25 |
| UA3DJB | 2" | BELL END | 24" | 670648080766 | 20 |
| UA3FJ | 2" | PLAIN END | 36" | 670648337860 | 20 |
| UA3FJB | 2" | BELL END | 36" | 670648081053 | 20 |
| UA3HJ | 2" | PLAIN END | 48" | 670648081183 | 20 |
| UA3HK | 2-1/2" | PLAIN END | 48" | 670648081206 | 15 |
| UA3DL | 3" | PLAIN END | 24" | 670648337822 | 10 |
| UA3DLB | 3" | BELL END | 24" | 670648080797 | 10 |
| UA3FL | 3" | PLAIN END | 36" | 670648337884 | 40 |
| UA3FLB | 3" | BELL END | 36" | 670648081084 | 18 |
| UA3HL | 3" | PLAIN END | 48" | 670648081220 | 10 |
| UA3DM | 3-1/2" | PLAIN END | 24" | 670648080803 | 5 |
| UA3HM | 3-1/2" | PLAIN END | 48" | 670648079869 | 5 |
| UA3DN | 4" | PLAIN END | 24" | 670648224542 | 10 |
| UA3DNB | 4" | BELL END | 24" | 670648080827 | 10 |
| UA3FN | 4" | PLAIN END | 36" | 670648224603 | 10 |
| UA3FNB | 4" | BELL END | 36" | 670648224610 | 10 |
| UA3HN | 4" | PLAIN END | 48" | 670648337938 | 5 |
| UA3HNB | 4" | BELL END | 48" | 670648079883 | 5 |
| UA3RNB | 4" | BELL END | 144" | 670648967180 | 30 |
| UA3SNB | 4" | BELL END | 150" | 670648338119 | 30 |
| UA3TNB | 4" | BELL END | 180" | 670648967197 | 5 |
| UA3FP | 5" | PLAIN END | 36" | 670648224634 | 5 |
| UA3FPB | 5" | BELL END | 36" | 670648081114 | 5 |
| UA3HP | 5" | PLAIN END | 48" | 670648145984 | 1 |
| UA3RPB | 5" | BELL END | 144" | 670648214819 | 30 |
| UA3UPB | 5" | BELL END | 240" | 670648184877 | 8 |
| UA3FR | 6" | PLAIN END | 36" | 670648224641 | 12 |
| UA3FRB | 6" | BELL END | 36" | 670648081121 | 4 |
| UA3HR | 6" | PLAIN END | 48" | 670648224689 | 4 |
| UA3HRB | 6" | BELL END | 48" | 670648967173 | 4 |
| UA3JR | 6" | PLAIN END | 72" | 670648141535 | 16 |
| UA3NR | 6" | PLAIN END | 120" | 670648141528 | 16 |
| UA3RRB | 6" | BELL END | 144" | 670648356229 | 8 |
| UA3SRB | 6" | BELL END | 150" | 670648126198 | 12 |
| UA3TRB | 6" | BELL END | 180" | 670648967203 | 5 |

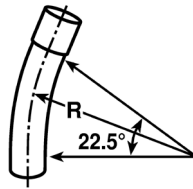

| Part Number | Trade Size | Type | Radius "B" | EACH UPC | Package Qty |
|-------------|------------|-----------|------------|--------------|-------------|
| UA5FF | 1" | PLAIN END | 36" | 670648054637 | 50 |
| UA5FG | 1-1/4" | PLAIN END | 36" | 670648054880 | 150 |
| UA5FH | 1-1/2" | PLAIN END | 36" | 670648054910 | 5 |
| UA5FHB | 1-1/2" | BELL END | 36" | 670648055672 | 20 |
| UA5CJ | 2" | PLAIN END | 18" | 670648068634 | 20 |
| UA5CJB | 2" | BELL END | 18" | 670648198003 | 20 |
| UA5DJ | 2" | PLAIN END | 24" | 670648068696 | 20 |
| UA5DJB | 2" | BELL END | 24" | 670648198058 | 20 |
| UA5EJ | 2" | PLAIN END | 30" | 670648338416 | 20 |
| UA5EJB | 2" | BELL END | 30" | 670648055696 | 5 |
| UA5FJ | 2" | PLAIN END | 36" | 670648068870 | 100 |
| UA5FJB | 2" | BELL END | 36" | 670648197822 | 20 |
| UA5HJ | 2" | PLAIN END | 48" | 670648054941 | 20 |
| UA5HJB | 2" | BELL END | 48" | 670648214871 | 20 |
| UA5VJ | 2" | PLAIN END | 300" | 670648111491 | 15 |
| UA5CK | 2-1/2" | PLAIN END | 18" | 670648068641 | 5 |
| UA5DK | 2-1/2" | PLAIN END | 24" | 670648068702 | 15 |
| UA5DKB | 2-1/2" | BELL END | 24" | 670648967210 | 15 |
| UA5EK | 2-1/2" | PLAIN END | 30" | 670648054958 | 15 |
| UA5FK | 2-1/2" | PLAIN END | 36" | 670648068887 | 50 |
| UA5HK | 2-1/2" | PLAIN END | 48" | 670648054965 | 30 |
| UA5CLB | 3" | BELL END | 18" | 670648198027 | 10 |
| UA5DL | 3" | PLAIN END | 24" | 670648068719 | 10 |
| UA5DLB | 3" | BELL END | 24" | 670648198072 | 10 |
| UA5EL | 3" | PLAIN END | 30" | 670648054972 | 5 |
| UA5ELB | 3" | BELL END | 30" | 670648004625 | 10 |
| UA5FL | 3" | PLAIN END | 36" | 670648068900 | 36 |
| UA5FLB | 3" | BELL END | 36" | 670648197846 | 10 |
| UA5HL | 3" | PLAIN END | 48" | 670648068894 | 30 |
| UA5VL | 3" | PLAIN END | 300" | 670648121063 | 30 |
| UA5DM | 3-1/2" | PLAIN END | 24" | 670648068726 | 5 |
| UA5EM | 3-1/2" | PLAIN END | 30" | 670648054989 | 5 |
| UA5FM | 3-1/2" | PLAIN END | 36" | 670648068917 | 5 |
| UA5HM | 3-1/2" | PLAIN END | 48" | 670648054996 | 25 |
| UA5DN | 4" | PLAIN END | 24" | 670648068733 | 10 |
| UA5DNB | 4" | BELL END | 24" | 670648197716 | 10 |
| UA5EN | 4" | PLAIN END | 30" | 670648068825 | 5 |
| UA5ENB | 4" | BELL END | 30" | 670648197785 | 30 |
| UA5FN | 4" | PLAIN END | 36" | 670648068924 | 5 |
| UA5FNB | 4" | BELL END | 36" | 670648197860 | 5 |
| UA5HN | 4" | PLAIN END | 48" | 670648069013 | 30 |
| UA5HNB | 4" | BELL END | 48" | 670648197952 | 30 |
| UA5IN | 4" | PLAIN END | 60" | 670648225556 | 30 |
| UA5JN | 4" | PLAIN END | 72" | 670648176087 | 30 |
| UA5RNB | 4" | BELL END | 144" | 670648214932 | 30 |
| UA5SN | 4" | PLAIN END | 150" | 670648225716 | 20 |
| UA5SNB | 4" | BELL END | 150" | 670648225723 | 30 |
| UA5TNB | 4" | BELL END | 180" | 670648967227 | 48 |
| UA5UNB | 4" | BELL END | 240" | 670648225815 | 30 |
| UA5VNB | 4" | BELL END | 300" | 670648225907 | 12 |
| UA5DPB | 5" | BELL END | 24" | 670648225440 | 5 |
| UA5EP | 5" | PLAIN END | 30" | 670648068832 | 3 |
| UA5EPB | 5" | BELL END | 30" | 670648197792 | 25 |
| UA5FP | 5" | PLAIN END | 36" | 670648068931 | 20 |
| UA5FPB | 5" | BELL END | 36" | 670648197877 | 20 |

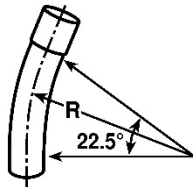

| Part Number | Trade Size | Type | Radius "B" | EACH UPC | Package Qty |
|-------------|------------|-----------|------------|--------------|-------------|
| UA5HP | 5" | PLAIN END | 48" | 670648069044 | 25 |
| UA5HPB | 5" | BELL END | 48" | 670648197969 | 12 |
| UA5IP | 5" | PLAIN END | 60" | 670648338577 | 3 |
| UA5RPB | 5" | BELL END | 144" | 670648214925 | 8 |
| UA5SP | 5" | PLAIN END | 150" | 670648225754 | 8 |
| UA5UPB | 5" | BELL END | 240" | 670648140286 | 20 |
| UA5VPB | 5" | BELL END | 300" | 670648225921 | 12 |
| UA5FR | 6" | PLAIN END | 36" | 670648068948 | 16 |
| UA5FRB | 6" | BELL END | 36" | 670648197884 | 16 |
| UA5HR | 6" | PLAIN END | 48" | 670648069020 | 12 |
| UA5HRB | 6" | BELL END | 48" | 670648197976 | 12 |
| UA5IR | 6" | PLAIN END | 60" | 670648225587 | 12 |
| UA5JR | 6" | PLAIN END | 72" | 670648141573 | 16 |
| UA5NR | 6" | PLAIN END | 120" | 670648141566 | 16 |
| UA5RR | 6" | PLAIN END | 144" | 670648089646 | 8 |
| UA5RRB | 6" | BELL END | 144" | 670648000696 | 8 |
| UA5SR | 6" | PLAIN END | 150" | 670648120820 | 5 |
| UA5TRB | 6" | BELL END | 180" | 670648967234 | 48 |
| UA5VR | 6" | PLAIN END | 300" | 670648338737 | 10 |

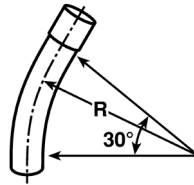

| Part Number | Trade Size | Type | Radius "R" | EACH UPC | Package Quantity |
|-------------|------------|-----------|------------|--------------|------------------|
| UA6CJ | 2" | PLAIN END | 18" | 670648068207 | 20 |
| UA6DJ | 2" | PLAIN END | 24" | 670648067262 | 100 |
| UA6DJB | 2" | BELL END | 24" | 670648055320 | 20 |
| UA6FJ | 2" | PLAIN END | 36" | 670648068184 | 50 |
| UA6FJB | 2" | BELL END | 36" | 670648055351 | 20 |
| UA6HJ | 2" | PLAIN END | 48" | 670648068191 | 50 |
| UA6HJB | 2" | BELL END | 48" | 670648055368 | 50 |
| UA6CK | 2-1/2" | PLAIN END | 18" | 670648068214 | 15 |
| UA6DK | 2-1/2" | PLAIN END | 24" | 670648081367 | 15 |
| UA6CL | 3" | PLAIN END | 18" | 670648068221 | 10 |
| UA6DL | 3" | PLAIN END | 24" | 670648067767 | 10 |
| UA6DLB | 3" | BELL END | 24" | 670648197693 | 10 |
| UA6FL | 3" | PLAIN END | 36" | 670648068283 | 30 |
| UA6FLB | 3" | BELL END | 36" | 670648197440 | 30 |
| UA6HL | 3" | PLAIN END | 48" | 670648068290 | 30 |
| UA6HLB | 3" | BELL END | 48" | 670648197532 | 48 |
| UA6DM | 3-1/2" | PLAIN END | 24" | 670648054835 | 5 |
| UA6FM | 3-1/2" | PLAIN END | 36" | 670648054859 | 30 |
| UA6HM | 3-1/2" | PLAIN END | 48" | 670648054866 | 25 |
| UA6DN | 4" | PLAIN END | 24" | 670648067866 | 30 |
| UA6FN | 4" | PLAIN END | 36" | 670648068382 | 30 |
| UA6FNB | 4" | BELL END | 36" | 670648197464 | 30 |
| UA6HN | 4" | PLAIN END | 48" | 670648068399 | 30 |
| UA6HNB | 4" | BELL END | 48" | 670648197556 | 30 |
| UA6IN | 4" | PLAIN END | 60" | 670648967241 | 36 |
| UA6INB | 4" | BELL END | 60" | 670648967258 | 36 |
| UA6FP | 5" | PLAIN END | 36" | 670648068436 | 12 |
| UA6FPB | 5" | BELL END | 36" | 670648055573 | 12 |
| UA6HP | 5" | PLAIN END | 48" | 670648068443 | 20 |
| UA6HPB | 5" | BELL END | 48" | 670648197563 | 20 |
| UA6VP | 5" | PLAIN END | 300" | 670648142686 | 25 |
| UA6FR | 6" | PLAIN END | 36" | 670648068481 | 12 |
| UA6FRB | 6" | BELL END | 36" | 670648055580 | 12 |
| UA6HR | 6" | PLAIN END | 48" | 670648068498 | 15 |
| UA6HRB | 6" | BELL END | 48" | 670648055597 | 12 |

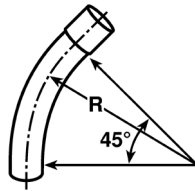

| Part Number | Trade Size | Type | Radius“ B” | EACH UPC | Package Quantity |
|-------------|------------|-----------|------------|--------------|------------------|
| UA7CF | 1" | PLAIN END | 18" | 670648067606 | 10 |
| UA7DF | 1" | PLAIN END | 24" | 670648067705 | 300 |
| UA7EF | 1" | PLAIN END | 30" | 670648054576 | 150 |
| UA7FF | 1" | PLAIN END | 36" | 670648067910 | 100 |
| UA7HF | 1" | PLAIN END | 48" | 670648054583 | 150 |
| UA7CG | 1-1/4" | PLAIN END | 18" | 670648067613 | 150 |
| UA7DG | 1-1/4" | PLAIN END | 24" | 670648067712 | 150 |
| UA7EG | 1-1/4" | PLAIN END | 30" | 670648054651 | 150 |
| UA7FG | 1-1/4" | PLAIN END | 36" | 670648067583 | 150 |
| UA7HG | 1-1/4" | PLAIN END | 48" | 670648067972 | 50 |
| UA7CH | 1-1/2" | PLAIN END | 18" | 670648067620 | 50 |
| UA7DH | 1-1/2" | PLAIN END | 24" | 670648067750 | 300 |
| UA7EH | 1-1/2" | PLAIN END | 30" | 670648054668 | 150 |
| UA7FH | 1-1/2" | PLAIN END | 36" | 670648067958 | 150 |
| UA7FHB | 1-1/2" | BELL END | 36" | 670648197112 | 150 |
| UA7HH | 1-1/2" | PLAIN END | 48" | 670648054675 | 100 |
| UA7BJB | 2" | BELL END | 12" | 670648174717 | 30 |
| UA7CJ | 2" | PLAIN END | 18" | 670648067637 | 50 |
| UA7CJB | 2" | BELL END | 18" | 670648196924 | 20 |
| UA7DJ | 2" | PLAIN END | 24" | 670648067668 | 400 |
| UA7DJB | 2" | BELL END | 24" | 670648196979 | 20 |
| UA7EJ | 2" | PLAIN END | 30" | 670648067675 | 100 |
| UA7EJB | 2" | BELL END | 30" | 670648197044 | 100 |
| UA7FJ | 2" | PLAIN END | 36" | 670648067682 | 50 |
| UA7FJB | 2" | BELL END | 36" | 670648197129 | 50 |
| UA7HJ | 2" | PLAIN END | 48" | 670648067699 | 50 |
| UA7HJB | 2" | BELL END | 48" | 670648226355 | 50 |
| UA7SJ | 2" | PLAIN END | 150" | 670648114560 | 1 |
| UA7CK | 2-1/2" | PLAIN END | 18" | 670648067651 | 5 |
| UA7DK | 2-1/2" | PLAIN END | 24" | 670648067811 | 30 |
| UA7DKB | 2-1/2" | BELL END | 24" | 670648196986 | 60 |
| UA7EK | 2-1/2" | PLAIN END | 30" | 670648054682 | 72 |
| UA7FK | 2-1/2" | PLAIN END | 36" | 670648067736 | 30 |
| UA7FKB | 2-1/2" | BELL END | 36" | 670648197136 | 30 |
| UA7HK | 2-1/2" | PLAIN END | 48" | 670648067743 | 5 |
| UA7CL | 3" | PLAIN END | 18" | 670648067644 | 30 |
| UA7CLB | 3" | BELL END | 18" | 670648196948 | 48 |
| UA7DL | 3" | PLAIN END | 24" | 670648226263 | 30 |
| UA7DLB | 3" | BELL END | 24" | 670648196993 | 30 |
| UA7EL | 3" | PLAIN END | 30" | 670648067774 | 30 |
| UA7ELB | 3" | BELL END | 30" | 670648197068 | 5 |
| UA7FL | 3" | PLAIN END | 36" | 670648067781 | 30 |
| UA7FLB | 3" | BELL END | 36" | 670648197143 | 30 |
| UA7HL | 3" | PLAIN END | 48" | 670648193527 | 30 |
| UA7HLB | 3" | BELL END | 48" | 670648197235 | 30 |
| UA7DM | 3-1/2" | PLAIN END | 24" | 670648054699 | 30 |
| UA7EM | 3-1/2" | PLAIN END | 30" | 670648054705 | 30 |
| UA7FM | 3-1/2" | PLAIN END | 36" | 670648067804 | 25 |

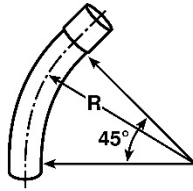

| Part Number | Trade Size | Type | Radius "B" | EACH UPC | Package Quantity |
|-------------|------------|-----------|------------|--------------|------------------|
| UA7DN | 4" | PLAIN END | 24" | 670648226270 | 30 |
| UA7DNB | 4" | BELL END | 24" | 670648197013 | 30 |
| UA7EN | 4" | PLAIN END | 30" | 670648067873 | 25 |
| UA7ENB | 4" | BELL END | 30" | 670648197082 | 25 |
| UA7FN | 4" | PLAIN END | 36" | 670648067880 | 30 |
| UA7FNB | 4" | BELL END | 36" | 670648197167 | 30 |
| UA7HN | 4" | PLAIN END | 48" | 670648067897 | 30 |
| UA7HNB | 4" | BELL END | 48" | 670648197259 | 30 |
| UA7IN | 4" | PLAIN END | 60" | 670648967265 | 36 |
| UA7INB | 4" | BELL END | 60" | 670648967272 | 30 |
| UA7JN | 4" | PLAIN END | 72" | 670648142693 | 30 |
| UA7NNB | 4" | BELL END | 120" | 670648339581 | 5 |
| UA7RN | 4" | PLAIN END | 144" | 670648142716 | 12 |
| UA7SN | 4" | PLAIN END | 150" | 670648226751 | 30 |
| UA7SNB | 4" | BELL END | 150" | 670648226768 | 25 |
| UA7EP | 5" | PLAIN END | 30" | 670648067927 | 25 |
| UA7EPB | 5" | BELL END | 30" | 670648055269 | 25 |
| UA7FP | 5" | PLAIN END | 36" | 670648067934 | 25 |
| UA7FPB | 5" | BELL END | 36" | 670648197174 | 25 |
| UA7HP | 5" | PLAIN END | 48" | 670648067941 | 25 |
| UA7HPB | 5" | BELL END | 48" | 670648197266 | 25 |
| UA7IPB | 5" | BELL END | 60" | 670648182682 | 25 |
| UA7JP | 5" | PLAIN END | 72" | 670648142709 | 25 |
| UA7NPB | 5" | BELL END | 120" | 670648226607 | 25 |
| UA7RP | 5" | PLAIN END | 144" | 670648142730 | 25 |
| UA7SPB | 5" | BELL END | 150" | 670648226782 | 25 |
| UA7UP | 5" | PLAIN END | 240" | 670648142723 | 25 |
| UA7FR | 6" | PLAIN END | 36" | 670648067989 | 8 |
| UA7FRB | 6" | BELL END | 36" | 670648197181 | 8 |
| UA7HR | 6" | PLAIN END | 48" | 670648067996 | 8 |
| UA7HRB | 6" | BELL END | 48" | 670648197273 | 8 |
| UA7IR | 6" | PLAIN END | 60" | 670648967289 | 2 |
| UA7JR | 6" | PLAIN END | 72" | 670648179514 | 16 |
| UA7NR | 6" | PLAIN END | 120" | 670648179521 | 16 |
| UA7RRB | 6" | BELL END | 144" | 670648356274 | 8 |

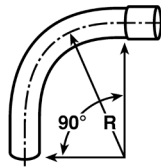

| Part Number | Trade Size | Type | Radius "B" | EACH UPC | Package Quantity |
|-------------|------------|-----------|------------|--------------|------------------|
| UA9CF | 1" | PLAIN END | 18" | 670648067101 | 150 |
| UA9CFB | 1" | BELL END | 18" | 670648227239 | 150 |
| UA9DF | 1" | PLAIN END | 24" | 670648067415 | 150 |
| UA9DFB | 1" | BELL END | 24" | 670648227314 | 150 |
| UA9EF | 1" | PLAIN END | 30" | 670648067255 | 10 |
| UA9EFB | 1" | BELL END | 30" | 670648079470 | 150 |
| UA9FF | 1" | PLAIN END | 36" | 670648067323 | 150 |
| UA9HF | 1" | PLAIN END | 48" | 670648067453 | 150 |
| UA9CG | 1-1/4" | PLAIN END | 18" | 670648227253 | 50 |
| UA9CGB | 1-1/4" | BELL END | 18" | 670648196504 | 100 |
| UA9DG | 1-1/4" | PLAIN END | 24" | 670648068061 | 150 |
| UA9DGB | 1-1/4" | BELL END | 24" | 670648196559 | 150 |
| UA9EG | 1-1/4" | PLAIN END | 30" | 670648067309 | 50 |
| UA9EGB | 1-1/4" | BELL END | 30" | 670648055009 | 50 |
| UA9FG | 1-1/4" | PLAIN END | 36" | 670648067507 | 150 |
| UA9FGB | 1-1/4" | BELL END | 36" | 670648196702 | 150 |
| UA9HG | 1-1/4" | PLAIN END | 48" | 670648067460 | 5 |
| UA9BHB | 1-1/2" | BELL END | 12" | 670648967296 | 20 |
| UA9CH | 1-1/2" | PLAIN END | 18" | 670648067125 | 120 |
| UA9CHB | 1-1/2" | BELL END | 18" | 670648196511 | 150 |
| UA9DH | 1-1/2" | PLAIN END | 24" | 670648067118 | 150 |
| UA9DHB | 1-1/2" | BELL END | 24" | 670648196566 | 150 |
| UA9EH | 1-1/2" | PLAIN END | 30" | 670648067316 | 120 |
| UA9EHB | 1-1/2" | BELL END | 30" | 670648055184 | 50 |
| UA9FH | 1-1/2" | PLAIN END | 36" | 670648068139 | 150 |
| UA9FHB | 1-1/2" | BELL END | 36" | 670648196719 | 150 |
| UA9HH | 1-1/2" | PLAIN END | 48" | 670648067477 | 5 |
| UA9CJ | 2" | PLAIN END | 18" | 670648067408 | 100 |
| UA9CJB | 2" | BELL END | 18" | 670648196528 | 100 |
| UA9DJ | 2" | PLAIN END | 24" | 670648967166 | 100 |
| UA9DJB | 2" | BELL END | 24" | 670648196573 | 100 |
| UA9EJ | 2" | PLAIN END | 30" | 670648067170 | 100 |
| UA9EJB | 2" | BELL END | 30" | 670648196641 | 100 |
| UA9FJ | 2" | PLAIN END | 36" | 670648067187 | 100 |
| UA9FJB | 2" | BELL END | 36" | 670648196726 | 100 |
| UA9HJ | 2" | PLAIN END | 48" | 670648067194 | 100 |
| UA9HJB | 2" | BELL END | 48" | 670648196818 | 100 |
| UA9JJ | 2" | PLAIN END | 72" | 670648227741 | 50 |
| UA9CK | 2-1/2" | PLAIN END | 18" | 670648067149 | 72 |
| UA9CKB | 2-1/2" | BELL END | 18" | 670648196535 | 72 |
| UA9DK | 2-1/2" | PLAIN END | 24" | 670648167214 | 72 |
| UA9DKB | 2-1/2" | BELL END | 24" | 670648196580 | 72 |
| UA9EK | 2-1/2" | PLAIN END | 30" | 670648067224 | 72 |
| UA9EKB | 2-1/2" | BELL END | 30" | 670648196658 | 72 |
| UA9FK | 2-1/2" | PLAIN END | 36" | 670648067231 | 72 |
| UA9FKB | 2-1/2" | BELL END | 36" | 670648196733 | 72 |
| UA9HK | 2-1/2" | PLAIN END | 48" | 670648067248 | 30 |
| UA9HKB | 2-1/2" | BELL END | 48" | 670648196825 | 30 |
| UA9CL | 3" | PLAIN END | 18" | 670648067156 | 30 |
| UA9CLB | 3" | BELL END | 18" | 670648196542 | 30 |
| UA9DL | 3" | PLAIN END | 24" | 670648227383 | 30 |
| UA9DLB | 3" | BELL END | 24" | 670648196597 | 30 |
| UA9EL | 3" | PLAIN END | 30" | 670648227420 | 30 |
| UA9ELB | 3" | BELL END | 30" | 670648196665 | 30 |
| UA9FL | 3" | PLAIN END | 36" | 670648067286 | 30 |

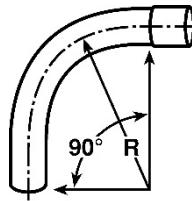

| Part Number | Trade Size | Type | Radius "B" | EACH UPC | Package Quantity |
|-------------|------------|-----------|------------|--------------|------------------|
| UA9FLB | 3" | BELL END | 36" | 670648196740 | 30 |
| UA9HL | 3" | PLAIN END | 48" | 670648067293 | 30 |
| UA9HLB | 3" | BELL END | 48" | 670648196832 | 30 |
| UA9IL | 3" | PLAIN END | 60" | 670648183269 | 1 |
| UA9DM | 3-1/2" | PLAIN END | 24" | 670648067200 | 30 |
| UA9DMB | 3-1/2" | BELL END | 24" | 670648196603 | 30 |
| UA9EM | 3-1/2" | PLAIN END | 30" | 670648067354 | 30 |
| UA9EMB | 3-1/2" | BELL END | 30" | 670648055191 | 30 |
| UA9FM | 3-1/2" | PLAIN END | 36" | 670648067330 | 30 |
| UA9FMB | 3-1/2" | BELL END | 36" | 670648196757 | 30 |
| UA9HM | 3-1/2" | PLAIN END | 48" | 670648067347 | 5 |
| UA9HMB | 3-1/2" | BELL END | 48" | 670648196849 | 30 |
| UA9CNB | 4" | BELL END | 18" | 670648186970 | 20 |
| UA9DN | 4" | PLAIN END | 24" | 670648067361 | 30 |
| UA9DNB | 4" | BELL END | 24" | 670648196610 | 30 |
| UA9EN | 4" | PLAIN END | 30" | 670648067378 | 30 |
| UA9ENB | 4" | BELL END | 30" | 670648196689 | 30 |
| UA9FN | 4" | PLAIN END | 36" | 670648067385 | 30 |
| UA9FNB | 4" | BELL END | 36" | 670648196764 | 30 |
| UA9HN | 4" | PLAIN END | 48" | 670648067392 | 30 |
| UA9HNB | 4" | BELL END | 48" | 670648196856 | 30 |
| UA9IN | 4" | PLAIN END | 60" | 670648227666 | 30 |
| UA9INB | 4" | BELL END | 60" | 670648227673 | 30 |
| UA9JN | 4" | PLAIN END | 72" | 670648227789 | 30 |
| UA9MN | 4" | PLAIN END | 108" | 670648967319 | 30 |
| UA9RN | 4" | PLAIN END | 144" | 670648142761 | 6 |
| UA9SNB | 4" | BELL END | 150" | 670648967333 | 1 |
| UA9VN | 4" | PLAIN END | 300" | 670648142778 | 30 |
| UA9EP | 5" | PLAIN END | 30" | 670648067422 | 8 |
| UA9EPB | 5" | BELL END | 30" | 670648196696 | 3 |
| UA9FP | 5" | PLAIN END | 36" | 670648067439 | 25 |
| UA9FPB | 5" | BELL END | 36" | 670648196771 | 25 |
| UA9HP | 5" | PLAIN END | 48" | 670648067446 | 8 |
| UA9HPB | 5" | BELL END | 48" | 670648196863 | 25 |
| UA9IP | 5" | PLAIN END | 60" | 670648227680 | 8 |
| UA9IPB | 5" | BELL END | 60" | 670648227697 | 12 |
| UA9JP | 5" | PLAIN END | 72" | 670648142754 | 25 |
| UA9TP | 5" | PLAIN END | 180" | 670648193817 | 12 |
| UA9VP | 5" | PLAIN END | 300" | 670648142785 | 12 |
| UA9FR | 6" | PLAIN END | 36" | 670648067484 | 12 |
| UA9FRB | 6" | BELL END | 36" | 670648196788 | 12 |
| UA9HR | 6" | PLAIN END | 48" | 670648067491 | 8 |
| UA9HRB | 6" | BELL END | 48" | 670648196870 | 12 |
| UA9IR | 6" | PLAIN END | 60" | 670648227703 | 8 |
| UA9IRB | 6" | BELL END | 60" | 670648227710 | 8 |
| UA9JRB | 6" | BELL END | 72" | 670648145199 | 1 |
| UA9LRB | 6" | BELL END | 96" | 670648967302 | 8 |
| UA9MR | 6" | PLAIN END | 108" | 670648967326 | 8 |
| UA9RRB | 6" | BELL END | 144" | 670648356236 | 8 |
| UA9SR | 6" | PLAIN END | 150" | 670648126334 | 5 |
| UA9TRB | 6" | BELL END | 180" | 670648120134 | 6 |
| UA9VR | 6" | PLAIN END | 300" | 670648967340 | 8 |

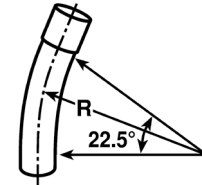
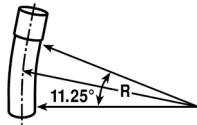

| Part Number | Trade Size | Type | Carton Quantity | EACH UPC |
|-------------|------------|-----------|-----------------|--------------|
| UB3AL | 3" | PLAIN END | 25 | 670648179194 |
| UB3AR | 6" | PLAIN END | 1 | 670648173512 |

| Part Number | Trade Size | Type | Carton Quantity | EACH UPC |
|-------------|------------|-----------|-----------------|--------------|
| UB5AL | 3" | PLAIN END | 20 | 670648177015 |
| UB5AN | 4" | PLAIN END | 12 | 670648179392 |
| UB5AP | 5" | PLAIN END | 1 | 670648182644 |
| UB5APB | 5" | BELL END | 1 | 670648187137 |

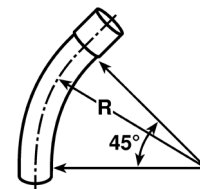
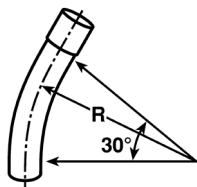

| Part Number | Trade Size | Type | Carton Quantity | EACH UPC |
|-------------|------------|-----------|-----------------|--------------|
| UB6AD | 1/2" | PLAIN END | 50 | 670648063615 |
| UB6AE | 3/4" | PLAIN END | 25 | 670648063622 |
| UB6AF | 1" | PLAIN END | 25 | 670648063639 |
| UB6AG | 1-1/4" | PLAIN END | 20 | 670648063646 |
| UB6AH | 1-1/2" | PLAIN END | 25 | 670648063653 |
| UB6AJ | 2" | PLAIN END | 20 | 670648063660 |
| UB6AK | 2-1/2" | PLAIN END | 20 | 670648063677 |
| UB6AL | 3" | PLAIN END | 18 | 670648063684 |
| UB6AN | 4" | PLAIN END | 10 | 670648063707 |
| UB6AP | 5" | PLAIN END | 1 | 670648063721 |
| UB6AR | 6" | PLAIN END | 1 | 670648063745 |

| Part Number | Trade Size | Type | Carton Quantity | EACH UPC |
|-------------|------------|-----------|-----------------|--------------|
| UB7AD | 1/2" | PLAIN END | 50 | 670648063417 |
| UB7AE | 3/4" | PLAIN END | 25 | 670648063424 |
| UB7AF | 1" | PLAIN END | 20 | 670648063431 |
| UB7AG | 1-1/4" | PLAIN END | 20 | 670648063448 |
| UB7AH | 1-1/2" | PLAIN END | 20 | 670648063455 |
| UB7AJ | 2" | PLAIN END | 20 | 670648063462 |
| UB7AK | 2-1/2" | PLAIN END | 20 | 670648063479 |
| UB7AL | 3" | PLAIN END | 1 | 670648063486 |
| UB7AN | 4" | PLAIN END | 1 | 670648063509 |
| UB7AP | 5" | PLAIN END | 1 | 670648063523 |
| UB7APB | 5" | BELL END | 1 | 670648187120 |
| UB7AR | 6" | PLAIN END | 1 | 670648063738 |

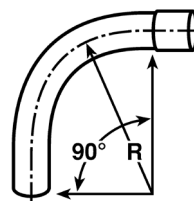

| Part Number | Trade Size | Type | Carton Quantity | EACH UPC |
|-------------|------------|-----------|-----------------|--------------|
| UB9AD | 1/2" | PLAIN END | 50 | 670648063219 |
| UB9AE | 3/4" | PLAIN END | 35 | 670648063226 |
| UB9AF | 1" | PLAIN END | 20 | 670648063233 |
| UB9AG | 1-1/4" | PLAIN END | 30 | 670648063240 |
| UB9AH | 1-1/2" | PLAIN END | 30 | 670648063257 |
| UB9AJ | 2" | PLAIN END | 20 | 670648063264 |
| UB9AK | 2-1/2" | PLAIN END | 10 | 670648063271 |
| UB9AL | 3" | PLAIN END | 1 | 670648063288 |
| UB9AN | 4" | PLAIN END | 1 | 670648063301 |
| UB9AP | 5" | PLAIN END | 1 | 670648063325 |
| UB9APB | 5" | BELL END | 1 | 670648187113 |

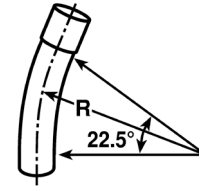
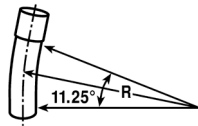

| Part Number | Trade Size | Type | Radius | Carton Quantity | EACH UPC |
|-------------|------------|------|--------|-----------------|--------------|
| UB3FP | 5" | PE | 36" | 5 | 670648183993 |

| Part Number | Trade Size | Type | Radius | Quantity | EACH UPC |
|-------------|------------|------|--------|----------|--------------|
| UB5DHB | 1-1/2" | BE | 24" | 20 | 670648185003 |
| UB5DJB | 2" | BE | 24" | 20 | 670648185010 |
| UB5FJB | 2" | BE | 36" | 25 | 670648187069 |
| UB5HJ | 2" | PE | 48" | 20 | 670648223361 |
| UB5DKB | 2-1/2" | BE | 24" | 15 | 670648185027 |
| UB5DL | 3" | PE | 24" | 5 | 670648161663 |
| UB5DLB | 3" | BE | 24" | 10 | 670648185034 |
| UB5FLB | 3" | BE | 36" | 25 | 670648187083 |
| UB5DN | 4" | PE | 24" | 50 | 670648173505 |
| UB5DNB | 4" | BE | 24" | 5 | 670648185041 |
| UB5FN | 4" | PE | 36" | 24 | 670648967357 |
| UB5FNB | 4" | BE | 36" | 20 | 670648187106 |
| UB5HN | 4" | PE | 48" | 1 | 670648223347 |
| UB5FP | 5" | PE | 36" | 1 | 670648184006 |
| UB5HP | 5" | PE | 48" | 1 | 670648223354 |

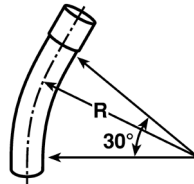

| Part Number | Trade Size | Type | Radius | Quantity | EACH UPC |
|-------------|------------|------|--------|----------|--------------|
| UB6FN | 4" | PE | 36" | 40 | 670648180305 |
| UB6FR | 6" | PE | 36" | 12 | 670648180312 |

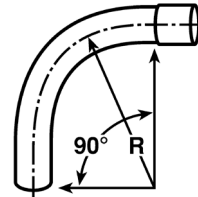
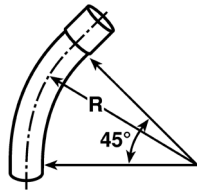

| Part Number | Trade Size | Type | Radius | Carton Quantity | EACH UPC |
|-------------|------------|------|--------|-----------------|--------------|
| UB7CF | 1" | PE | 18" | 1 | 670648055832 |
| UB7DF | 1" | PE | 24" | 1 | 670648055849 |
| UB7FF | 1" | PE | 36" | 1 | 670648055863 |
| UB7HF | 1" | PE | 48" | 1 | 670648055870 |
| UB7DG | 1-1/4" | PE | 20" | 1 | 670648055894 |
| UB7FG | 1-1/4" | PE | 36" | 1 | 670648055917 |
| UB7HG | 1-1/4" | PE | 48" | 1 | 670648055924 |
| UB7CH | 1-1/2" | PE | 18" | 1 | 670648055931 |
| UB7DH | 1-1/2" | PE | 24" | 1 | 670648055948 |
| UB7DHB | 1-1/2" | BE | 24" | 1 | 670648185058 |
| UB7FH | 1-1/2" | PE | 36" | 1 | 670648193732 |
| UB7HH | 1-1/2" | PE | 48" | 1 | 670648055962 |
| UB7CJ | 2" | PE | 18" | 1 | 670648193800 |
| UB7DJ | 2" | PE | 24" | 1 | 670648193855 |
| UB7DJB | 2" | BE | 24" | 1 | 670648185065 |
| UB7FJ | 2" | PE | 36" | 1 | 670648193954 |
| UB7FJB | 2" | BE | 36" | 1 | 670648187052 |
| UB7HJ | 2" | PE | 48" | 1 | 670648055986 |
| UB7DK | 2-1/2" | PE | 24" | 1 | 670648056006 |
| UB7DKB | 2-1/2" | BE | 24" | 1 | 670648185072 |
| UB7FK | 2-1/2" | PE | 36" | 1 | 670648193749 |
| UB7HK | 2-1/2" | PE | 48" | 1 | 670648056020 |
| UB7CL | 3" | PE | 18" | 1 | 670648341126 |
| UB7DL | 3" | PE | 24" | 1 | 670648194357 |
| UB7DLB | 3" | BE | 24" | 1 | 670648185089 |
| UB7FL | 3" | PE | 36" | 1 | 670648194456 |
| UB7FLB | 3" | BE | 36" | 1 | 670648187076 |
| UB7HL | 3" | PE | 48" | 1 | 670648194500 |
| UB7DN | 4" | PE | 24" | 1 | 670648194852 |
| UB7DNB | 4" | BE | 24" | 1 | 670648185096 |
| UB7FN | 4" | PE | 36" | 1 | 670648194951 |
| UB7FNB | 4" | BE | 36" | 1 | 670648187090 |
| UB7HN | 4" | PE | 48" | 1 | 670648195002 |
| UB7FP | 5" | PE | 36" | 1 | 670648195200 |
| UB7HP | 5" | PE | 48" | 1 | 670648195255 |
| UB7FR | 6" | PE | 36" | 1 | 670648056075 |
| UB7HR | 6" | PE | 48" | 1 | 670648193848 |
| UB7IR | 6" | PE | 60" | 1 | 670648176018 |

| Part Number | Trade Size | Type | Radius | Carton Quantity | EACH UPC |
|-------------|------------|------|--------|-----------------|--------------|
| UB9CF | 1" | PE | 18" | 1 | 670648190533 |
| UB9DF | 1" | PE | 24" | 1 | 670648191066 |
| UB9FF | 1" | PE | 36" | 1 | 670648191219 |
| UB9HF | 1" | PE | 48" | 1 | 670648191257 |
| UB9CG | 1-1/4" | PE | 18" | 1 | 670648190540 |
| UB9DG | 1-1/4" | PE | 24" | 1 | 670648191073 |
| UB9FG | 1-1/4" | PE | 36" | 1 | 670648191226 |
| UB9HG | 1-1/4" | PE | 48" | 1 | 670648191264 |
| UB9CH | 1-1/2" | PE | 18" | 1 | 670648190557 |
| UB9DH | 1-1/2" | PE | 24" | 1 | 670648190601 |
| UB9DHB | 1-1/2" | BE | 24" | 1 | 670648185102 |
| UB9FH | 1-1/2" | PE | 36" | 1 | 670648190700 |
| UB9HH | 1-1/2" | PE | 48" | 1 | 670648191271 |
| UB9CJ | 2" | PE | 18" | 1 | 670648190809 |
| UB9DJ | 2" | PE | 24" | 1 | 670648190854 |
| UB9DJB | 2" | BE | 24" | 1 | 670648158861 |
| UB9FJ | 2" | PE | 36" | 1 | 670648190953 |
| UB9FJB | 2" | BE | 36" | 1 | 670648187045 |
| UB9HJ | 2" | PE | 48" | 1 | 670648191004 |
| UB9CK | 2-1/2" | PE | 18" | 1 | 670648190816 |
| UB9DK | 2-1/2" | PE | 24" | 1 | 670648191103 |
| UB9DKB | 2-1/2" | PE | 24" | 1 | 670648341515 |
| UB9FK | 2-1/2" | PE | 36" | 1 | 670648191202 |
| UB9FKB | 2-1/2" | BE | 36" | 1 | 670648111637 |
| UB9HK | 2-1/2" | PE | 48" | 1 | 670648191295 |
| UB9CL | 3" | PE | 18" | 1 | 670648191301 |
| UB9DL | 3" | PE | 24" | 1 | 670648191356 |
| UB9DLB | 3" | BE | 24" | 1 | 670648341522 |
| UB9FL | 3" | PE | 36" | 1 | 670648191455 |
| UB9FLB | 3" | BE | 36" | 1 | 670648229196 |
| UB9HL | 3" | PE | 48" | 1 | 670648191509 |
| UB9DN | 4" | PE | 24" | 1 | 670648191851 |
| UB9DNB | 4" | BE | 24" | 1 | 670648185119 |
| UB9FN | 4" | PE | 36" | 1 | 670648191950 |
| UB9FNB | 4" | BE | 36" | 1 | 670648229219 |
| UB9HN | 4" | PE | 48" | 1 | 670648192001 |
| UB9HNB | 4" | BE | 48" | 1 | 670648229271 |
| UB9NN | 4" | PE | 120" | 1 | 670648213782 |
| UB9FP | 5" | PE | 36" | 1 | 670648192209 |
| UB9HP | 5" | PE | 48" | 1 | 670648192254 |
| UB9IP | 5" | PE | 60" | 1 | 670648189490 |
| UB9FR | 6" | PE | 36" | 1 | 670648191240 |
| UB9HR | 6" | PE | 48" | 1 | 670648229318 |
| UB9IR | 6" | PE | 60" | 1 | 670648176025 |